

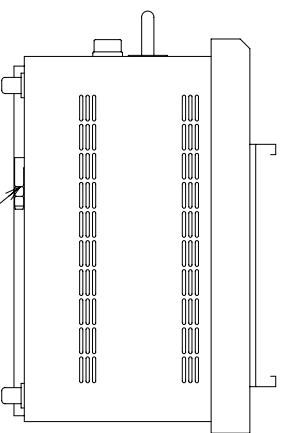

Model	Outer Size	Grill Size	kW		Suitable size of gas hose?	
	mm		mm	natural gas	LPG	natural gas
KA-55G	540x610x384	400x350	10.5	10.5	Hose Diameter 13mm	Hose Diameter 9.5mm
KA-75G	740x610x384	500x350	15.7	15.7	Hose Diameter 13mm	Hose Diameter 9.5mm
KA-95G	940x610x384	800x350	20.9	20.9	20A	20A
KA-115G	1,140x610x384	1,000x350	26.2	26.2	20A	20A
KA-135G	1,340x610x384	1,200x350	31.4	31.4	20A	20A
KA-155G	1,540x610x384	1,400x350	36.6	36.6	20A	20A
KA-175G	1,740x610x384	1,600x350	41.9	41.9	20A	20A

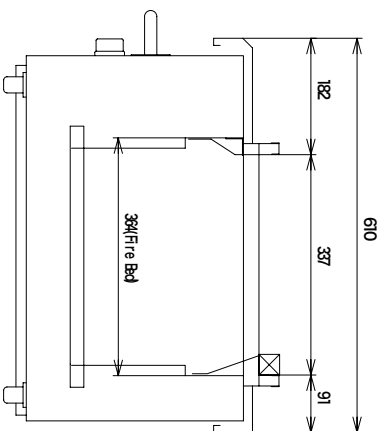
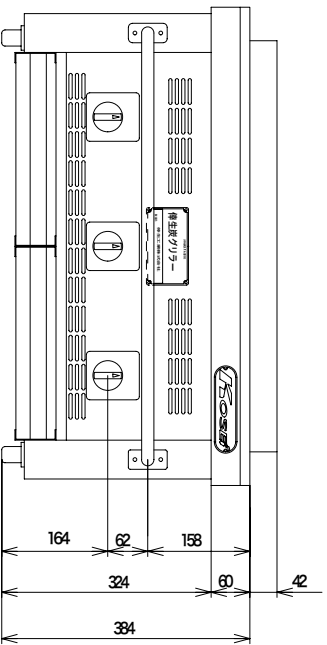
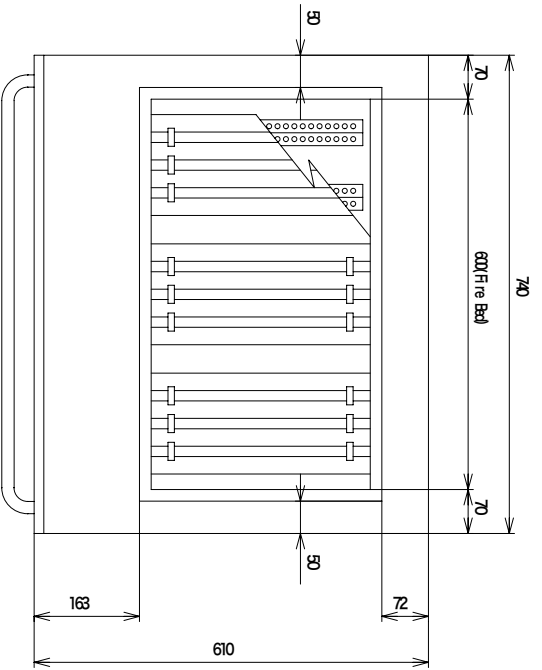

Name of Model	K A-75G	
Dimension	Width	740
	Length	610
(m/m)	Height	384
	Gas Consumption	1.5. 7KW
Ignition	Natural gas	1.5. 7KW
	L.P.G	1.5. 7KW
Gas connection (inside Dia)	Natural gas	13mm Hose Diameter
Weight (Kg)	L.P.G	9.5mm Hose Diameter
Clearance from flammable materials (cm)	upper side	20
	front	15
Structure of a Floor	Structure of non-combustible	

**Kosei Kogyou Co.**

**Kosei Charcoal Grill**

**K A-75G type**

Name of Product :

Model

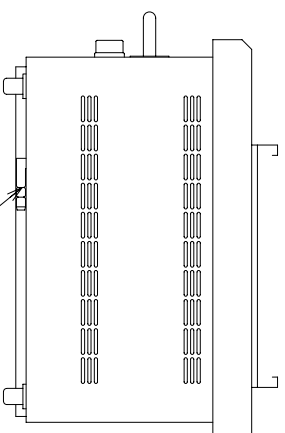
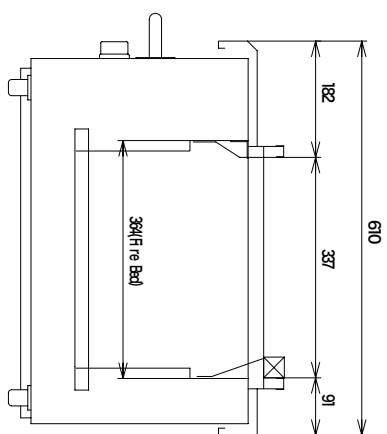
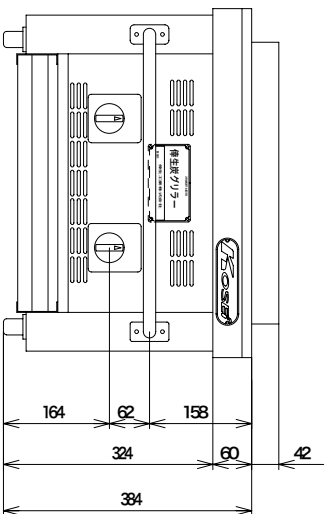
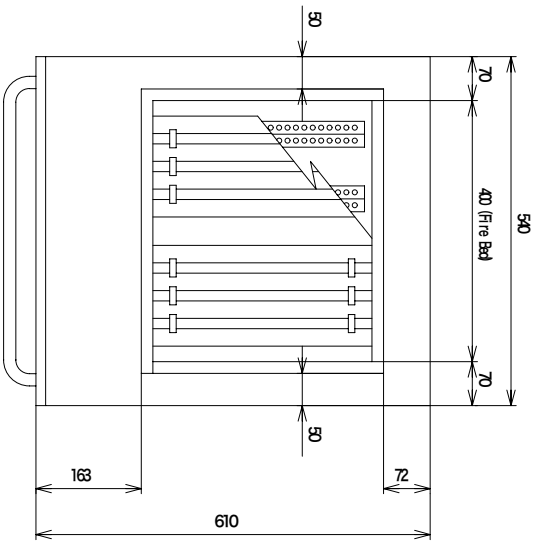

Da of Hse ext 37mm da for Natural Gas, 37mm da for LPG

Name of Model	K A-55G	
Dimension	Width	540
	Length	610
	Height	384
Gas Consumption	Natural gas	10.5 KW
	L.P.G	10.5 KW
Ignition	Fixed spark ignition	
Gas connection (Inside Dia.)	Natural gas	1.3mm Hse Diameter
	L.P.G	9.5mm Hse Diameter
Weight (K.g)		4.5K.g
Clearance from flammable materials (cm)	Upper side	hood
	Back	2.0
Structure of a Floor	front	1.5
	Structure of non-combustible	

Name of Product :

Model

Kosei Kogyou Co.

Kosei Charcoal Grill

KA-55G type

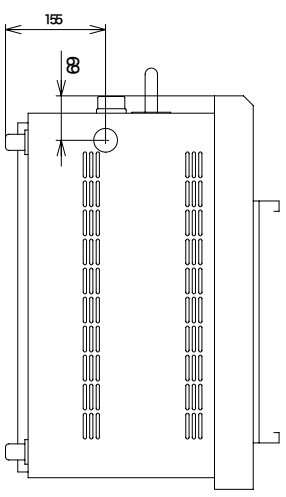
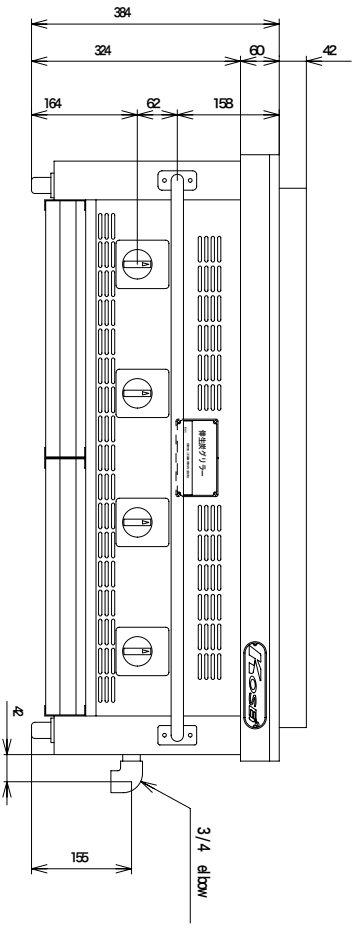
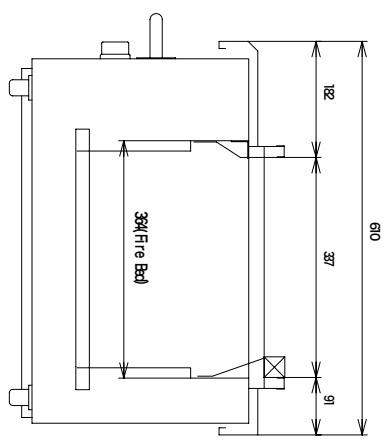
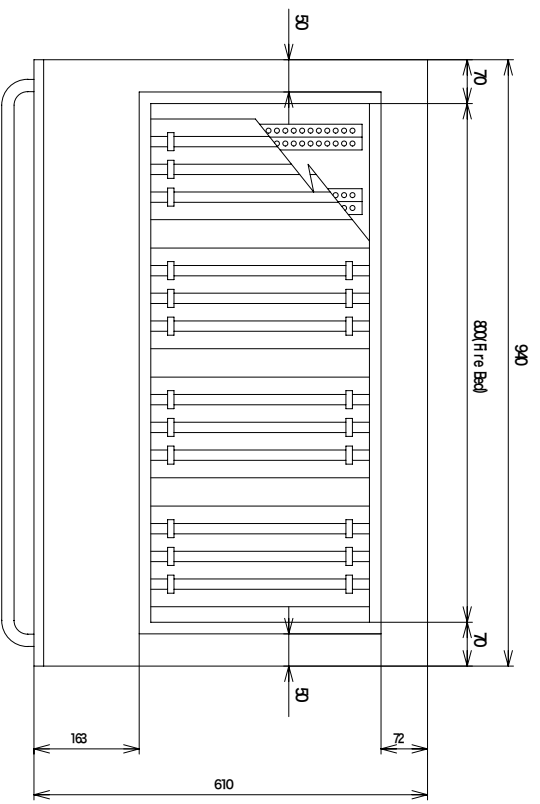

Name of Model		KA-95G	
Dimension (m/m)	Width	940	
	Length	610	
Gas Consumption	Natural gas	3.84	
	L.P.G	2.9W	
Ignition	Front spark ignition	2.9W	
	Natural gas	7.0K <sub>9</sub>	
Gas connection (Inch Dia.)	Natural gas	3/4 elbow	
	L.P.G	3/4 elbow	
Weight (kg)	7.0K <sub>9</sub>		
	Appearance from front	upper side	hood
flamable materials (cm)	back	2.0	
	front	1.5	
Structure of a front	Structure of non-combustible		

Name of Product :

Model

Kosei Kogyou Co.

Kosei Charcoal Grill

KA-95G type

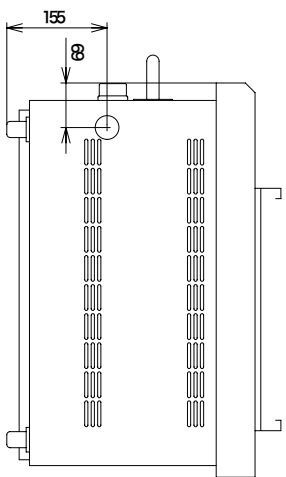
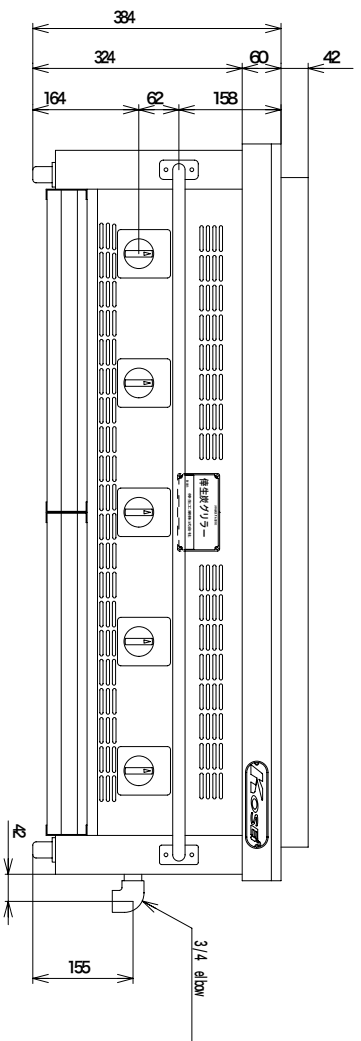
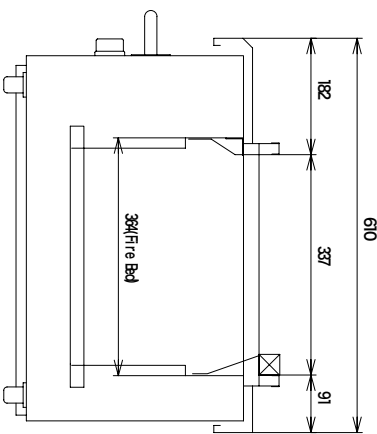
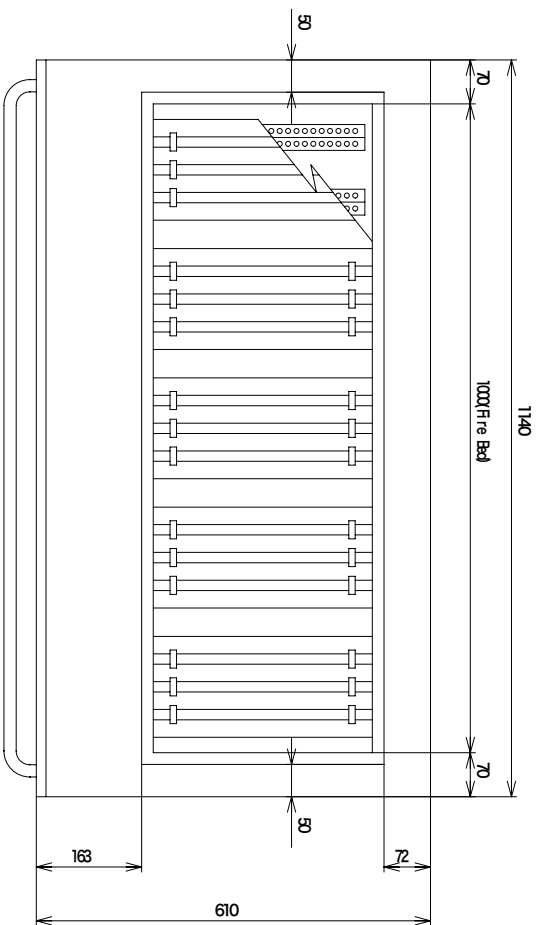

Name of Model	KA-115G	
Dimensions	Width	1,140
	Length	610
	Height	384
Gas Consumption (m <sup>3</sup> /m)	Natural gas	2.6, 2KW
	LPG	2.6, 2KW
Ignition	Flame spark ignition	
Gas connection (inside Dia.)	Natural gas	3/4 elbow
	LPG	3/4 elbow
Weight (kg)		8.0kg
Clearance from flame radiator (cm)	Around the grill	upper hood 2.0
	front	back 1.5
Structure of a Floor		Structure of non-combustible

**Kosei Kogyou Co.**

Name of Product : **Kosei Charcoal Grill**

Name of Product :

Model

**KA-115G type**

--	--	--	--	--	--

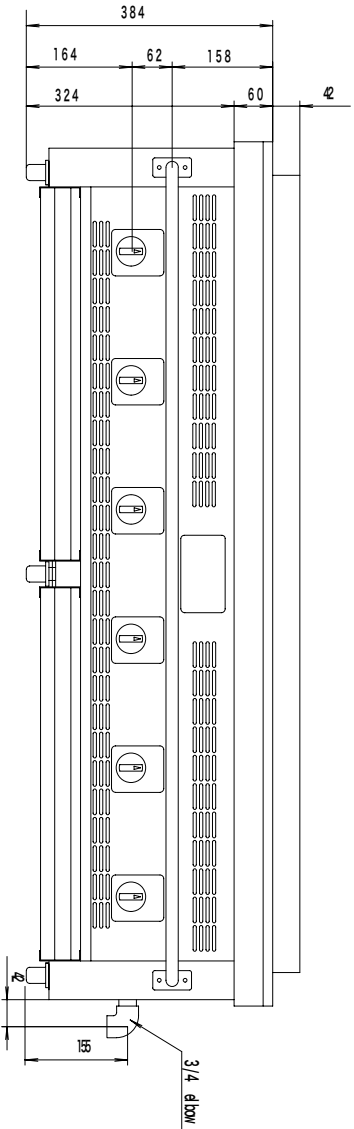
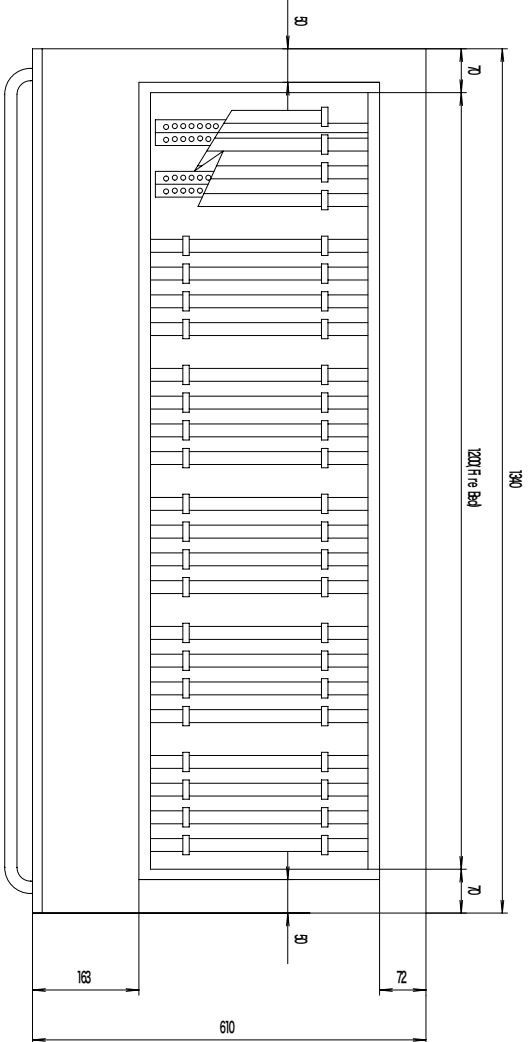

Name of Model		KA-1356	
Dimension	Width	1,340	
	Length	610	
Height (m/m)	Hi grt	384	
Gas Consumption	Natural gas	31.4kW	
	L P G	31.4kW	
Ignition	Zero spark ignition	3/4 d blow	
Gas correction (l/side Dia.)	Natural gas	3/4 d blow	
	L P G	3/4 d blow	
Weight (K g)	95KG		
Clearance from flammable materials (c m)	Upper side	hood	20
	front back	grill of front	15
Structure of a floor		Structure of non-combustible	

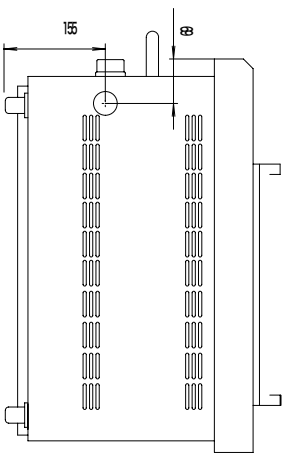
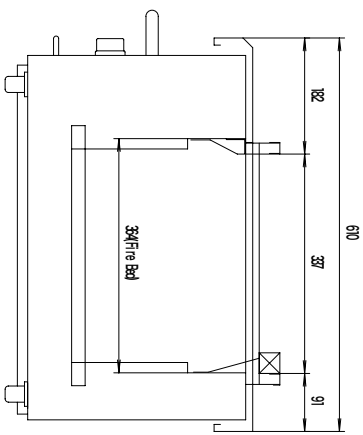

**Kosei Kogyou Co.**

**Kosei Charcoal Grill er**

Name of Product :

Model

**KA-135 Gtype**

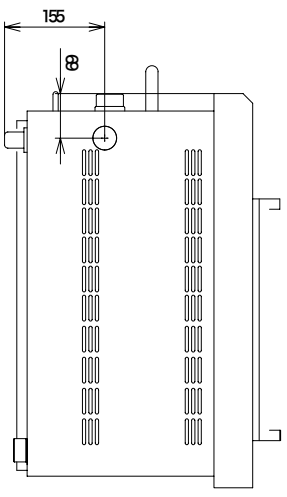
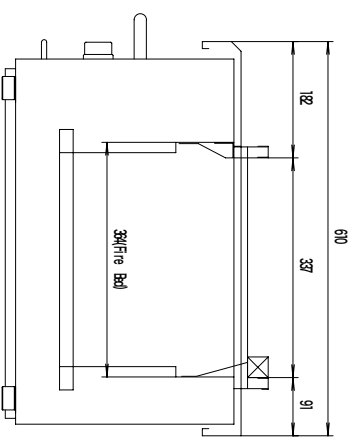
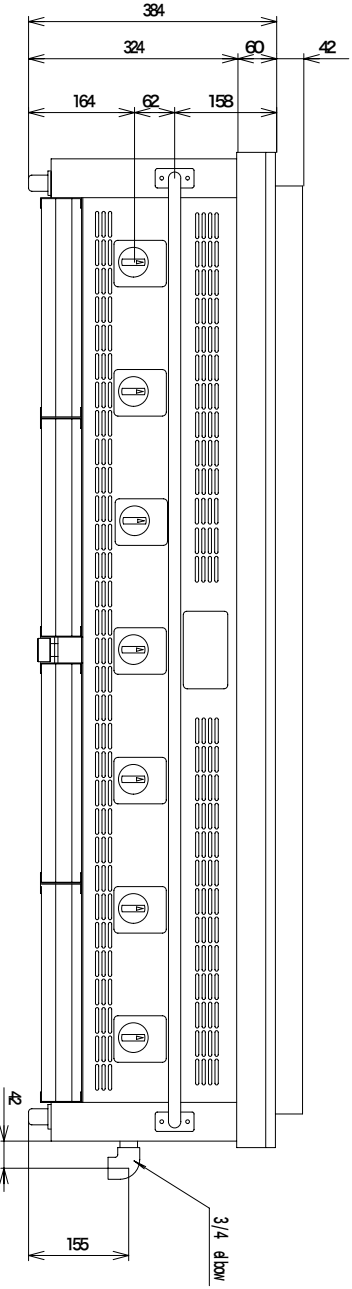
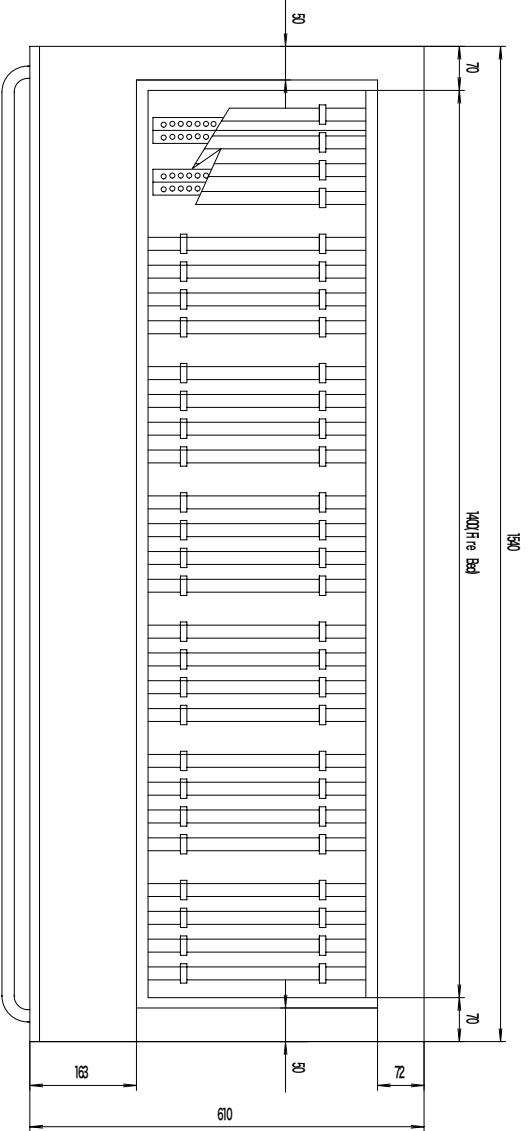

Name of Model	KA-155G	
Dimension	Width	1,540
	Length	610
	Height	384
Gas Consumption	Natural gas	3.6, 6KW
	L.P.G	3.6, 6KW
Ignition	Pilot spark ignition	
Gas connection (inside Dia.)	Natural gas	3/4 elbow
	L.P.G	3/4 elbow
Weight (kg)	105kg	
Clearance from flammable materials (cm)	Around the front	upper hood side back
		20
		15
Structure of a Floor	Structure of non-combustible	

Name of Product :

Model

**Kosei Kogyou Co.**

**Kosei Charcoal Grill KA-155G type**

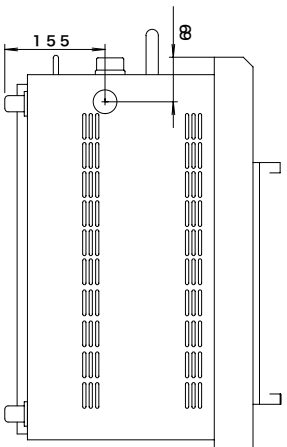
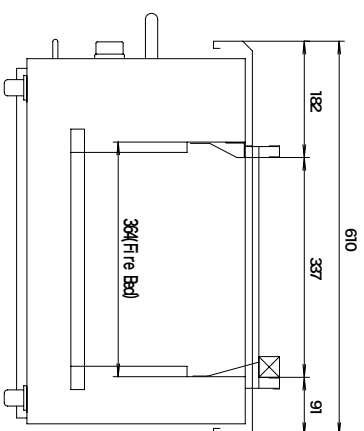
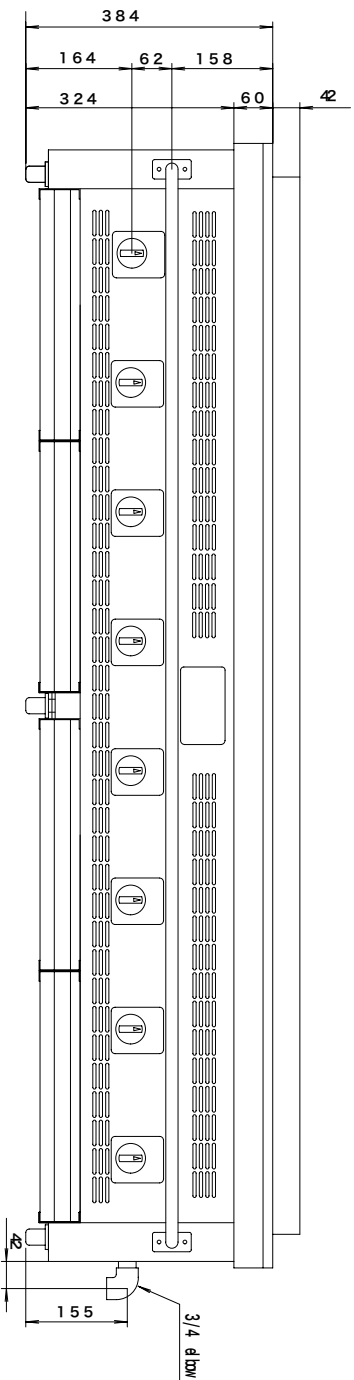
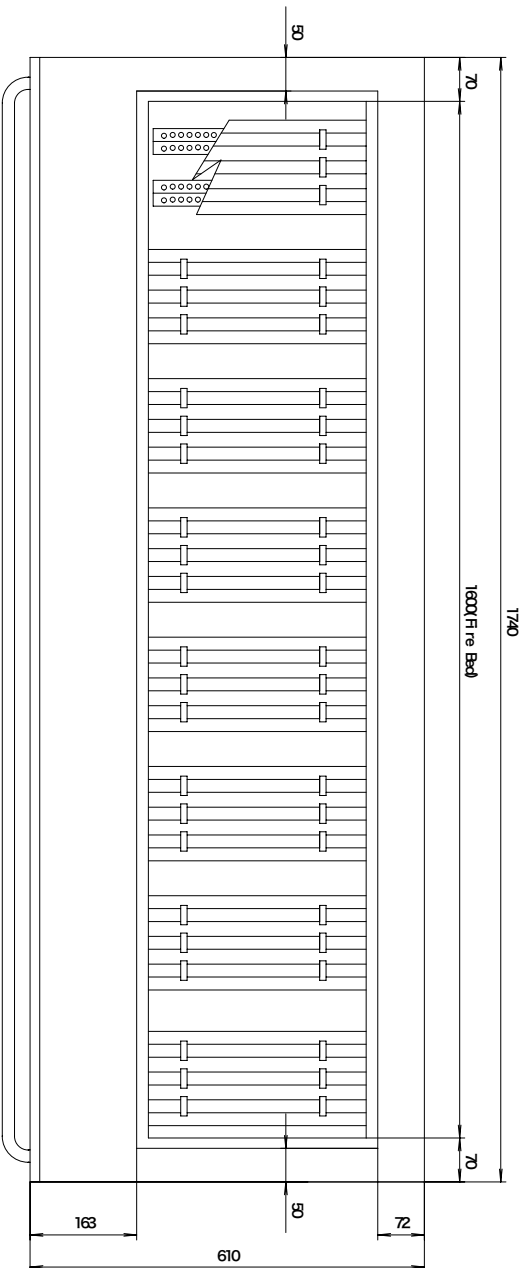

Net of Model	KA-175G	
Dimension	Width	1.740
	Length	610
(m/m)	Height	384
Gas Consumption	Natural Gas	41.9 KW
	L.P.G	41.9 KW
Ignition	Flame spark ignition	
	Gas connection (Inlet dia.)	3/4 elbow
Weight (kg)	L.P.G	120 Kg
	Natural Gas	3/4 elbow
Structure of a front	upper side	hood
	lower side	20
Structure of a rear	front	
	back	15
Structure of non-combustible materials		

Name of Product :

**Kosei Kogyou Co.**

**Kosei Charcoal Grill**

Model

**KA-175G type**